

**The Bull Dog BD-200
Dual Setpoint Pump Controller
Installation and Operating Manual**



BLUE RIBBON SALES & SERVICES

2770 Long Road, Grand Island, NY 14072

Tel. (716) 773-9300 • Fax (716) 773-5019

brsales@blueribboncorp.com • www.blueribboncorp.com

CONTENTS

Dimensions	1
Specifications.	2
Getting Started.	3
Model Identification	3
Installation	4
Wiring.	5-7
Front Panel Functions.	8-9
Home Display.	9
Security Level Selection	10
Lead/Lag Operation.	11
Seal Failure Operation.	11-12
Over Temperature Operation.	12-13
Analog Retransmission Operation	13
Serial Communication Operation	14
Menu Selections	15
Secondary Menu	15-16
Secure Menu	17-23
Alarm Type and Action	20-22
Diagnostic Error Messages	24-25
Programming Chart	26-28
Programming Example	28-31

DIMENSIONS

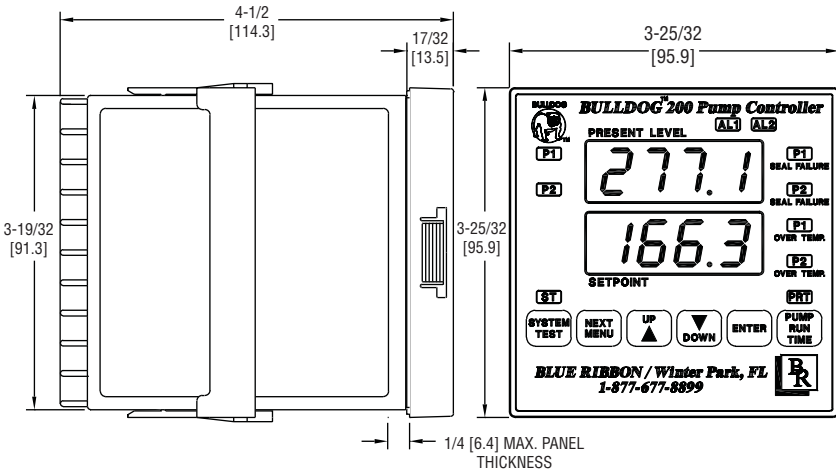

SPECIFICATIONS

Inputs: 4 to 20 mA DC or 2.0 to 10.0 V DC selectable.

Input Impedance: Current input: 10 ohms, Voltage input: 100K ohms.

Output Ratings:

Control Relays: SPDT, rated 10A @ 240 VAC res., 1/4 hp @120 VAC, 1/3 hp @ 240 VAC.

Alarm Relays: SPST, 3A @ 240 VAC res., 1/10 hp @ 120 VAC.

Control Type: on/off, reverse or direct acting.

Power Requirements: 100 to 240 VAC nominal, +10%-15%, 50 to 400 Hz, single phase; 132 to 240 VDC nominal, +10%-15%.

Power Consumption: 7.5 VA maximum.

Accuracy: 0.25% of span, 1 least significant digit.

Display: Two 4 digit, 7 segment 0.56" high LED's.

Display Resolution: 1 count.

Memory Backup: Nonvolatile memory (no batteries required).

Serial Communications: Optional RS-232 or RS-485 with Modbus® protocol.

Ambient Operating Temperature / RH: 14 to 131° F (-10 to 55° C) / 0 to 90% up to 104° F (40° C) non-condensing, 10 to 50% at 131° F (55° C) non-condensing.

Weight: 16 oz. (454 g).

Front Panel Rating: Meets UL Type 4X (IP66).

Loop Power Supply (isolated): 24 VDC @ 50 mA, regulated.

Seal Failure (Moisture Sensor):

Power Supply to Moisture Sensor: 2.5 VDC.

Search Current: 3 micro amps.

Resistance Sensitivity: 10K to 500K ohms.

Resistance Resolution: 10K ohm steps.

Over Temperature:

Input: Dry contact on Transistor switch (NPN open collector type).

Current: 1 mADC.

Isolation: Shares common ground with transmitter input.

Alarm On-Off Differential: 1 count.

Set Point Range: Selectable.

Power Voltage Stability: 0.05% over the power voltage range.

Temperature Stability: 100 ppm / °C typical, 200 ppm / °C maximum.

Common Mode Rejection: 140 db minimum at 60 Hz.

Normal Mode Rejection: 65 db typical, 60 db at 60 Hz.

Isolation:

Relay: 1500 VAC to all other inputs and outputs.

24 VDC Loop Power: 500 VAC to other inputs and outputs.

Process Output: 500 VAC to other inputs and outputs.

Seal Failure Input: 500 VAC to other inputs and outputs.

Storage Temperature: -40 to 176° F (-40 to 80° C).

Agency Approvals: UL 508.

GETTING STARTED

1. Install the control as described on page 4.
2. Wire the control following the instructions on pages 5 through 7. Page 5 contains basic wiring for the control. If using the BD-200 transmitter power supply follow the additional directions on page 6. Wiring instructions for the 232 and 485 series communication options is included on page 7.
3. Familiarize yourself with the front key pad functions and read the menu structure prior to starting the programming process. A programming chart with the menu structure and spaces to write your programming values is included on pages 26 through 28. This chart can be a helpful tool to save time in programming. For further assistance programming examples are included on pages 28 through 31.

MODEL IDENTIFICATION

BD-200 - 
Options

Options:

232	RS-232 Modbus-RTU Serial Communications. Allows remote computer to read and write all control parameters.
485	RS-485 Modbus-RTU Serial Communications. Allows remote computer to read and write all control parameters.
RV	Analog retransmission of input, 2 to 10 VDC.

Input Ranges

Process Input Types

The 0 to 20 mADC, 4 to 20 mADC, 0 to 10 VDC, and 2 to 10 VDC inputs are fully scalable from a minimum of 100 count span placed anywhere within the range of -1999 to +9999. Decimal point position is adjustable from the zero place (9999), tenths (999.9), hundredths (99.99), or thousandths (9.999).

INSTALLATION

Mount the instrument in a location that will not be subject to excessive temperature, shock, or vibration (see Specifications for specific tolerances). All models are designed for mounting in an enclosed panel.

Select the position desired for the instrument on the panel. Prepare the panel by cutting and deburring the required opening.

From the front of the panel, slide the housing through the cut out. The housing gasket should be against the housing flange before installing.

From the rear of the panel slide the mounting collar over the housing. Hold the housing with one hand and using the other hand, push the collar evenly against the panel until the springs are compressed. The ratchets will hold the mounting collar and housing in place.

Figure 1 – Panel Cut Out Dimensions

Panel cut-out:
3.620 x 3.620 in,
+0.032/-0.000
(92 x 92 mm,
+0.8/-0.0)



CAUTION: It is not necessary to remove the instrument chassis from the housing for installation. If the instrument chassis is removed from the housing, you must follow industry standard practice for control and protection against Electro-Static Discharge (ESD). Failure to exercise good ESD practices may cause damage to the instrument.

WIRING

Do not run transmitter wiring or other class 2 wiring in the same conduit as power leads. Use only the probe or transmitter for which the control has been programmed. Maintain separation between wiring of sensor, auxiliary in or out, and other wiring. See the "Secure Menu" for input selection.

Supply connections should be made in accordance with the National Electrical Code per Article 300, and local regulations. All line voltage output circuits must have a common disconnect and be connected to the same pole of the disconnect.

Input wiring for probe or transmitter is rated CLASS 2.

Control wiring is as shown in Figure 2 below.

Figure 2 - Wiring

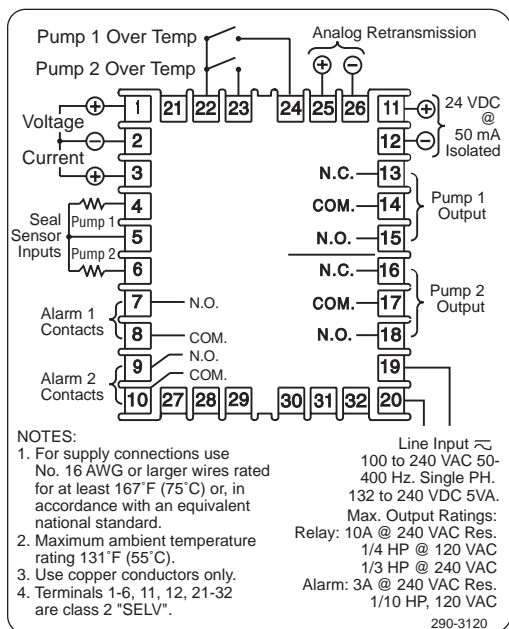

If not using pump over temperature inputs then jumper terminals 22 to 23 and 22 to 24.

WIRING FOR TRANSMITTER INPUTS USING INTEGRAL POWER SUPPLY

Wire power and outputs as shown on previous page. Wiring for two-wire transmitters shown below in Figure 3. All wiring shown in Figure 3 is Class 2.

Figure 3 - Transmitter Wiring

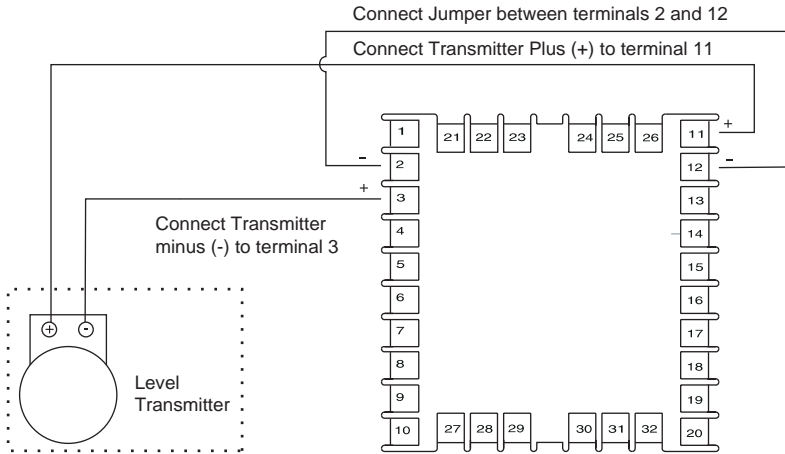

For three or four wire transmitters follow the wiring instructions provided with your transmitter.



DO NOT wire the 24 Volt Power Supply across the input of the control. Damage to the control input circuitry will result.

WIRING FOR 485 AND 232 SERIAL COMMUNICATION OPTIONS

Wire power and outputs as shown on page 5. Wiring for options is shown in Figure 4 below. All wiring shown below is Class 2. Shielded twisted pair is recommended for Option 485.



DO NOT run signal wiring in the same conduit or chase as the power wiring. Erratic operation or damage to the control circuitry will result.

Figure 4 – Wiring for Options

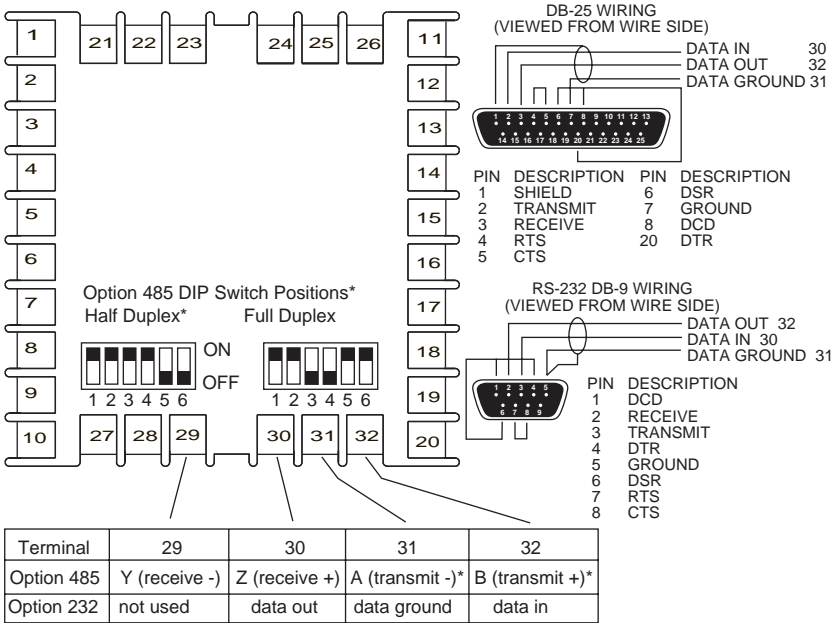

*For half-duplex operation wire only A and B. Do not connect to Y and Z.

FRONT PANEL FUNCTIONS

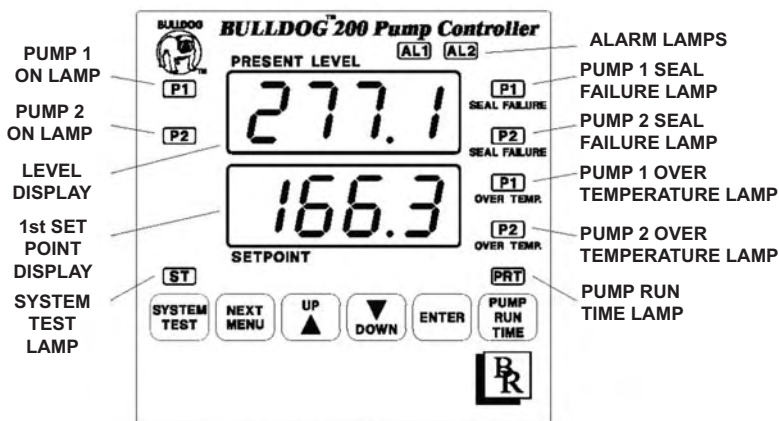

Key functions are as follows:

NEXT MENU **NEXT MENU**: Pressing the **NEXT MENU** **NEXT MENU** key for 2 seconds will bring up the Secondary menu starting at the SP1H menu item. Holding the key for 5 seconds will bring up the Secure menu starting with the menu item SECR. Once in the menus, pressing the **NEXT MENU** **NEXT MENU** key advances the display to the next menu item. May also be used in conjunction with other keys as noted below.



SYSTEM TEST **SYSTEM TEST**: When Test menu item is "On" depressing this key for three seconds will make the BD-200 Controller go through a system test. See page 18 for explanation of system test function.



UP **UP ARROW**: Increments a value, changes a menu item, or selects the item to ON. The maximum value obtainable is 9999 regardless of decimal point placement.

DOWN **DOWN ARROW**: Decrements a value, changes a menu item, or selects the item to OFF. The minimum value obtainable is -1999 regardless of decimal point placement.

ENTER **ENTER**: The **ENTER** **ENTER** key is used to store the value of menu items once they are changed to a new value. If the **ENTER** **ENTER** key is not pressed after changing the value the item will revert to the previously stored value.

Pump Run Time **PUMP RUN TIME**: Pressing this key will cause the BD-200 Controller to display the total run time (in hours) that the pump(s) have been on since the last reset.

  **NEXT MENU & DOWN ARROW:** Pressing these keys simultaneously will allow backing up one menu item, or if at the first menu item they will cause the display to return to the primary menu. If an alarm condition has occurred, these keys may be used to reset the alarm.

  **NEXT MENU & ENTER:** Pressing these keys simultaneously and holding them for 5 seconds allows recovery from the various error messages. The following menu items will be reset:

ALIH : Alarm inhibit

CHEC CAL : Check calibration error

Correct the problems associated with the above conditions before using these reset keys. More than one error could be present. Caution is advised since several items are reset at one time.



THE HOME DISPLAY



The home display is the normal display while the control is operating. If no errors or functions are active, the HOME display will indicate the Process Variable (the level that is being measured) on the top display and the SP1H value, Pump 1 On Set Point, on the bottom display.

Error messages may over-ride the HOME display. See ERROR MESSAGES on pages 24 and 25.

While in the **Secondary Menu**, if no key is pressed for a period of 30 seconds, the display will return to the HOME position displaying the process value. While in the **Secure Menu**, if no key is pressed for a period of 60 seconds, the display will return to the HOME position displaying the process value. Outputs are disabled (turned off) when **the Secure Menu** is active.

SECURITY LEVEL SELECTION

Three levels of security are provided. The *SEC* menu item security level may be viewed or changed at any time regardless of the present security level in the Secure menu. The display shows the current security level. To change security levels change the password value using the  UP ARROW or  DOWN ARROW keys and pressing the  ENTER key. Refer to the password table (following) for the correct value to enter for the security level desired.

To set the access level to, for example, *2*, at the *SEC* menu item press the  UP ARROW key until the upper display shows the password, *1 1 0 1*. Press the  ENTER key. The display will blink, and return with the level value, *2*, in the upper display.

The password values shown in the table cannot be altered. Retain a copy of these pages for future reference. This is the only reference made to password values in this instruction book.

Password Table

Menu	Security Level Status	Displayed Value When Viewed	Password Value To Enter
Secondary Secure	Locked Locked	2	1101
Secondary Secure	Unlocked Locked	3	1011
Secondary Secure	Unlocked Unlocked	4	111

LEAD/LAG OPERATION

The BD-200 pump controller is designed to easily operate a pair of pumps in the most efficient manner possible. The controller has a 'lead/lag' feature that allows two pumps to operate in an alternating fashion to minimize wear.

The Blue Ribbon BD-22 controller has a pair of set points each for pump 1 and pump 2. If the lead/lag feature is turned off, *SP 1H* and *SP 1L* control pump 1 and *SP 2H* and *SP 2L* control pump 2. If the lead/lag feature is turned on, pumps 1 and 2 will be controlled in the alternating fashion described below. In all cases the P1 lamp will indicate activity of pump 1 and the P2 lamp will indicate activity of pump 2. The lead/lag operation is set in the Secure menu with the item *LdLg*.

Lead/Lag On

After installation, set the *SP 1H* to the high level (pump on point) for standard operation. Set *SP 1L* to the low level (pump off point). Set the *SP 2H* to the level where you want BOTH pumps to turn on (emergency pump on). Set the *SP 2L* to the level where you want the second pump to turn off (emergency pump off).

The controller will not allow you to set *SP 1H* below *SP 1L*, *SP 1L* above *SP 1H*, *SP 2H* below *SP 2L*, or *SP 2L* above *SP 2H*. The controller will not allow you to set any set point or alarm point above or below the programmed scale. No error messages are generated. The displayed value will stop at an allowable point just above (or below, as the case may be) the maximum or minimum allowed.

In normal operation, when the *SP 1H* point is reached, one of the pumps will turn on. When lead/lag is turned on, pumps 1 and 2 will alternate. If the level reaches the *SP 2H* point, both pumps will be turned on until the *SP 2L* point is reached, where one of the pumps will turn off. When *SP 1L* is reached, remaining running pump will turn off. The last pump off will not be the next pump on.

Lead/Lag Off

If lead/lag is turned off, *SP 1H* and *SP 1L* control pump 1 and *SP 2H* and *SP 2L* control pump 2. There is no alternating function.

SEAL FAILURE OPERATION

The Blue Ribbon BD-200 Controller is designed to work with most types of submersible pump moisture sensors to detect outer seal failure. Most often the moisture sensor is a conductance device that detects moisture in the oil chamber indicating an outer seal failure. Using a 2.5 VDC power supply sent to the moisture sensor the BD-200 Controller monitors the resistance between the probe lead wires or the single probe lead wire and ground. The resistance set point is adjustable over the range of 10K to 500K ohms adjustable in 10K ohm steps, and is set with Secondary menu items *SFS 1* and *SFS 2*. When the resistance of the moisture sensor decreases below the resistance set point the BD-200 controller goes into the programmed seal failure mode.

In the Secure menu the value of *PSF* is programmed for the action of the BD-200 based on the condition of a seal failure. If set to " *AUTO*", when pump moisture sensor indicates that there is a seal failure condition then the corresponding pump seal failure lamp is lit on the controller. The pump will remain in service with only the lamp indication of failure. The lamp will be turned off automatically when the seal failure condition has ceased.

If *PSF* is set to " *RES* ", when pump moisture sensor indicates that there is a seal failure condition then the corresponding pump seal failure lamp is lit on the controller. If the BD-200 is only being used with one pump or being used with two pumps with the lead/lag function turned off then no action is taken by the BD-200 with the operation of the pumps. The failure indication lamp will be manually reset as described in the next paragraph. If the BD-200 is being used with two pumps with the lead/lag function turned on then the failed pump will automatically become the lag pump, the remaining pump will become the lead pump, and the alternation will be discontinued. The lamp indication and pump alternation can be manually reset as described in the next paragraph.

Once the pump has been repaired the seal failure action can be reset with the values of *P1SF* and *P2SF* in the Secondary menu. The item *P1SF* or *P2SF* will display *FAIL* if the corresponding pump has met the condition of a seal failure. Press the  ENTER key to reset. If the pump moisture sensor is still in the fail condition then the control will not reset. If the moisture sensor is no longer in the fail condition then the display will revert to "----".

OVER TEMPERATURE OPERATION

Most pumps have an installed normally closed thermostat for over temperature protection of the pump. The thermostat has a preset value from the pump manufacturer at which point the pump needs to be shut down. The Blue Ribbon BD-200 detects when the thermostat signal changes to open and shuts down the pump.

In the Secure menu the value of *POT* is programmed for the action of the BD-200 based on the condition of the over temperature. When the pump temperature sensor indicates that there is an over temperature condition the pump will be held out of service and the corresponding pump over temperature lamp is lit on the controller. If using the BD-200 with two pumps with the lead/lag function turned on then the failed pump will automatically be taken out of service, the remaining pump will become the lead pump, and the alternation will be discontinued. When controlling two pumps with the lead/lag function off the failed pump will automatically be taken out of service and the remaining pump will be controlled by the *SP1H* and *SP1L* set points.

If *POT* is set to " *AUTO*" then the pump will be automatically placed back into service and the lamp turned off when the over temperature condition has ceased. If set to " *RES* " then the pump will remain out of service and the lamp lit until the corresponding manual reset *P1OT* or *P2OT* is reset in the Secondary menu (described in the next paragraph). The pump cannot be brought back into service until the

over temperature condition has ceased.

Once the pump has cooled down the BD-200 Controller can be reset with the values of *P10t* and *P20t* in the Secondary menu. The item *P10t* or *P20t* will display *FR 11t* if the pump has met the condition of over temperature. Press the  ENTER key to reset. If the pump temperature sensor is still in the fail condition then the control will not reset. If the temperature input is no longer in the fail condition then the display will revert to “----”.

ANALOG RETRANSMISSION OPERATION

The analog retransmission allows the Process Variable to be sent as an analog signal to an external device. The signal may be either 2 to 10 VDC (option RV) or 4 to 20 mADC (standard). The output may be changed in the field from one to the other by the toggle switch located on the top printed circuit board, factory standard is mADC.

Wire the output as shown on page 5.

To set up the analog retransmission, first determine the scale range that the analog signal will represent. The maximum scale is 9999 counts. In the Secure menu set *POL* for the scale value that will be represented by the low end of the analog signal (2 Volts or 4 mA). Set *POH* for the scale value that will be represented by the high end of the analog signal (10 Volts or 20 mA). Operation is automatic. There are no further programming steps required. The values of *POL* and *POH* must be within the programmed scale range. The scale range is set by the *SCAL* and *SCAH* in the Secure menu.

OPTION 232, 485 SERIAL COMMUNICATION OPERATION

The serial communications options allow the control to be written to and read from a remote computer or other similar digital device. Communication is allowed either through a RS-485 (Option 485) port, or a RS-232 (Option 232) port.

Wire the communication lines as shown on Page 7. Wiring for the RS-485 is run from control to control in a daisy chain fashion with a termination resistor (120 ohms) across the transmit and receive terminals of the last control in the chain. Set the RS-485 DIP switch for half or full duplex as appropriate for your application. The DIP switch is located on the communications board plugged into the center of the bottom board of the control.

Select the control address and communication baud rate with the *Addr* and *bAud* menu items in the Secure Menu. THE BAUD RATE AND ADDRESS MENU ITEMS WILL TAKE EFFECT ON THE NEXT POWER UP OF THE CONTROL. BE SURE TO POWER CYCLE THE CONTROL BEFORE USING THE NEW BAUD RATE AND ADDRESS.

In operation, you have the option of preventing a write command from the host computer. To prevent the host from writing to the control change the *LOrE* menu item in the Secondary Menu to *LOC*. To allow the host to write commands to the control set *LOrE* to *rE*. (The host does have the ability to change the *LOrE* state, but it is not automatic.)

If your system depends on constant reading or writing to and from the host, you may wish to set the No Activity Timer (*nAt*) to monitor the addressing of the control. When the *LOrE* is set to *rE* and the *nAt* is set to any value other than *OFF*, the control will expect to be addressed on a regular basis. If the control is not addressed in the time set by the value of *nAt*, then the control will display the error message *[HEC LOrE]*. To clear the message set *LOrE* to *LOC*.





MENU SELECTIONS

Notation Conventions for the Menus

Because of the number of features available in this control, information is included that may not apply to your specific control. All usable features are included in this book, but may not be used in your process. To increase clarity the following conventions are used:

1. Certain features or functions shown in this book are contextual. This means that Menu Items may or may not appear, depending on other Menu Item selections. Whenever this occurs, a notation is made in the Menu Item that "controls" or "directs" other menu items. If you are looking for a particular menu item and can't find it, check the menu item that is its "control" for proper setting.
2. The "#" symbol is used in two ways. It is used inside a group of characters to indicate which set point function (SP1 or SP2) is being affected. It is also used before a group of characters of a menu item to indicate that there may be more than one selection or value for that menu item.

Secondary Menu

Press the  **NEXT MENU** key for 2 seconds to start the menu. Press  **NEXT MENU** advance to the next menu item. Press  **UP ARROW** or  **DOWN ARROW** to change the value in the display. Press  **ENTER** to retain the value.

SP 1H Pump 1 On Set Point. Factory Default 23 . 1 (feet).

SP 1L Pump 1 Off Set Point. Factory Default 0 . 0 (feet).

SP2H Pump 2 On Set Point. Factory Default 23 . 1 (feet).





SP2L Pump 2 Off Set Point. Factory Default 0 . 0 (feet).

A 1Hi Alarm 1 High: Factory Default 23 . 1 (feet).





A2Lo Alarm 2 Low: Factory Default 2 . 0 (feet).

SFS1 Pump 1 Seal Failure Set Point: Select 10 to 500 in any increment of 10. Sets the resistance set point at which the controller will trip the Seal Failure based on the input from the pump moisture sensor. The controller will activate the Seal Failure condition based on a decrease of resistance to the set point. Selectable resistance range is from 10K to 500K ohms with the factory default at 120K ohms.

FS2 Pump 2 Seal Failure Set Point: Select 10 to 500 in any increment of 10. Sets the resistance set point at which the controller will trip the Seal Failure based on the input from the pump moisture sensor. The controller will activate the Seal Failure condition based on a decrease of resistance to the set point. Selectable resistance range is from 10K to 500K ohms with the factory default at 120K ohms.

- P1rn** Pump 1 Run Time: Total ON Time for Pump 1 in HOURS since last reset (0000 - 9999 hours).
- P2rn** Pump 2 Run Time: Total ON Time for Pump 2 in HOURS since last reset (0000 - 9999 hours).
- P1SF** Pump 1 Reset for Seal Failure. Displays “----” when pump 1 is in normal operating condition based on seal failure input. Displays **FR IL** if pump 1 has met the condition of a seal failure. Press the  ENTER key to reset. If pump 1 seal failure is still in the fail condition then the control will not reset. If the seal failure input is no longer in fail condition then the display will revert to “----”.
- P2SF** Pump 2 Reset for Seal Failure. Displays “----” when pump 2 is in normal operating condition based on seal failure input. Displays **FR IL** if pump 2 has met the condition of seal failure. Press the  ENTER key to reset. If pump 2 seal failure is still in the fail condition then the control will not reset. If the seal failure input is no longer in fail condition then the display will revert to “----”.
- P1OT** Pump 1 Reset for Over Temperature. Displays “----” when pump 1 is in normal operating condition based on temperature input. Displays **FR IL** if pump 1 has met the condition of over temperature. Press the  ENTER key to reset. If pump 1 temperature input is still in the fail condition then the control will not reset. If the temperature input is no longer in fail condition then the display will revert to “----”.
- P2OT** Pump 2 Reset for Over Temperature. Displays “----” when pump 2 is in normal operating condition based on temperature input. Displays **FR IL** if pump 2 has met the condition of over temperature. Press the  ENTER key to reset. If pump 2 temperature input is still in the fail condition then the control will not reset. If the temperature input is no longer in fail condition then the display will revert to “----”.

Secure Menu

Press the  **NEXT MENU** key for 2 seconds to start the menu. Press  **NEXT MENU** advance to the next menu item. Press  **UP ARROW** or  **DOWN ARROW** to change the value in the display. Press  **ENTER** to retain the value. **OUTPUTS ARE DISABLED (TURNED OFF) WHILE CONTROL IS IN THE SECURE MENU.**

- SECR** Security Code: See the Security Level Selection and the Password Table on page 10, in order to enter the correct password. Factory Default is 4 .
- SCAH** Scale High: Select 100 to 9999 counts above **SCAL** . The total span between **SCAL** and **SCAH** must be within 11998 counts. Maximum setting range is -1999 to +9999 counts. Factory Default is 23 . 1 .
- SCAL** Scale Low: Select 100 to 9999 counts below **SCAH** . The total span between **SCAL** and **SCAH** must be within 11998 counts. Maximum setting range is -1999 to +9999 counts. Factory Default is 0 . 0 .
- DPE** Decimal Point Positioning: Select 0 , 0 . 0 , 0 . 00 , or 0 . 000 . All Menu items related to the input will be affected. Factory default is 0 . 0 .
- 515T** Set Point 1 State: Select **P IN** or **P OUT** .Factory default is **P OUT** .
P IN Pump In (Direct Action). As the input increases the output will increase.
P OUT Pump Out (Reverse Action). As the input increases the output will decrease.
- 525T** Set Point 2 State: Select **P IN** , **P OUT** or **OFF** . Factory default is **P OUT** .
P IN Pump In (Direct Action). As the input increases the output will increase.
P OUT Pump Out (Reverse Action). As the input increases the output will decrease.
OFF This setting is for applications when the MPC is used with only one pump systems. All Menu items relating to Set Point 2 will not appear.
- LDL9** Lead / Lag: Select **ON** or **OFF** . Factory default is **ON** . (See page 11)
ON The Lead/Lag function is enabled. The outputs of **SP1** and **SP2** will alternate.
OFF The Lead/Lag function is disabled.
- INPC** Input Correction: Select ± 500 counts. This feature allows the input value to be changed to agree with an external reference or to compensate for sensor error. Note: **INPC** is reset to zero when the input type is changed, or when decimal position is changed.

OSUP Zero Suppression: Select **On** or **OFF**. Factory default is **On**.

OFF The input range will start at 0 (zero) Input.

On The input range will start at 4.00 mA or 2.00 V.

inP Input Type: Select one of the following. Refer to the Input wiring section for the proper wiring. Factory Default is **Curr**.

Curr DC Current Input 0.0 to 20.0 or 4.0 to 20.0 mA.

Volt DC Voltage Input 0.0 to 10.0 or 2.0 to 10.0 volts.

- - - - Reserved

POT Pump Over Temperature: Select **AUTO** or **RES**. When pump temperature sensor indicates that there is an over temperature condition the pump will be held out of service and the corresponding pump over temperature lamp is lit on the controller. If using the BD-200 with two pumps and lead/lag on then the remaining pump becomes the lead pump. If lead/lag is turned off then the remaining pump becomes controlled by Set Point 1. See page 12.

AUTO The pump will be automatically placed back into service and the lamp turned off when the over temperature condition has ceased.



RES The pump will remain out of service and the lamp lit until the corresponding manual reset **P1OT** or **P2OT** is reset in the Secondary menu. The pump cannot be brought back into service until the over temperature condition has ceased.

PSF Pump Seal Failure: Select **AUTO** or **RES**. See page 11.

AUTO When pump moisture sensor indicates that there is a seal failure condition the corresponding pump seal failure lamp is lit on the controller. The pump will remain in service with only the lamp indication of failure. The lamp will automatically turn off when failure condition ceases.

RES When pump moisture sensor indicates that there is a seal failure condition the corresponding pump seal failure lamp is lit on the controller. If the BD-200 is being used with two pumps and the lead/lag feature turned on then the failed pump will automatically become the lag pump, the remaining pump the lead pump, and the alternation discontinued. The seal failure action is reset manually with the values of **P1SF** and **P2SF** in the Secondary menu. The control will only reset if the pump moisture sensor is no longer in a failed condition.

TEST System Test: Select **On** or **OFF**. When **On** is selected the "System Test" key on the front panel will be activated. By depressing this key for 3 seconds the controller will simulate an input from **SCAL** to **SCAN** and back to **SCAL** over a period of 32 seconds. This test will run continuously until the SYSTEM TEST key is pressed again. When the controller is in System Test Mode the lamp above the System Test Key will be ON.

- PrSt** Pump Run Time Reset: Select **On** or **OFF**. Selecting **On** will allow Pump Run Time to be reset in the Secondary menu while an **OFF** selection will not allow Pump Run Time to be reset.
- SPH** Set Point High: Select from the highest input range value to **SPH** value. This will set the maximum **SP1H** or **SP2H** value that can be entered. The value for **SP1H** or **SP2H** will stop moving when this value is reached. Factory Default is **23.1**.
- SPL** Set Point Low: Select from the lowest input range value to **SPH** value. This will set the minimum **SP1L** or **SP2L** value that can be entered. The value for **SP1L** or **SP2L** will stop moving when this value is reached. Factory Default is **0.0**.
- SP1** Setpoint 1 Power Interrupt. Select **On** or **OFF**. Factory default is **OFF**.
- On** Alarm Power Interrupt is **On**. Output will automatically reset on power-up if no alarm condition exists.
- OFF** Alarm Power Interrupt is **OFF**. Output will be in the alarm condition on power-up regardless of condition of process.
- SP1H** Setpoint 1 Inhibit: Select **On** or **OFF**. Factory default is **OFF**.
- On** Alarm Inhibit is **On**. Alarm action is suspended until the process value first enters a non-alarm condition.
- OFF** Alarm Inhibit is **OFF**.
- SP2** Setpoint 2 Power Interrupt. Select **On** or **OFF**. Factory default is **OFF**.
- On** Alarm Power Interrupt is **On**. Output will automatically reset on power-up if no alarm condition exists.
- OFF** Alarm Power Interrupt is **OFF**. Output will be in the alarm condition on power-up regardless of condition of process.
- SP2H** Setpoint 2 Inhibit: Select **On** or **OFF**. Factory default is **OFF**.
- On** Alarm Inhibit is **On**. Alarm action is suspended until the process value first enters a non-alarm condition.
- OFF** Alarm Inhibit is **OFF**.
- PER** The Peak feature stores the highest input the control has measured since the last reset or Power On. At Power On **PER** is reset to the present input. To manually reset the value **PER** must be in the lower display. Press the  ENTER key to reset. **PER** will be reset and display the present input value.
- VAL** The Valley feature stores the lowest input the Controller has measured since the last reset or Power On. At Power On **VAL** is reset to the present input. To manually reset the value **VAL** must be in the lower display. Press the  ENTER key. **VAL** will be reset and display the present input value.

ALARM TYPE AND ACTION

Caution: In any critical application where failure could cause expensive product loss or endanger personal safety, a redundant limit controller is required.



When setting an alarm value for an absolute alarm ($AL1 = ABS$ or $AL2 = ABS$), simply set the value at which the alarm is to occur.

When setting the alarm value for a deviation alarm ($AL1 = dE$ or $AL2 = dE$), set the difference in value from the Set Point ($SP IH$) desired.

Since the input for the BD-200 is driven from a transmitter, the input display can be programmed in different ways. Regardless of the position of the decimal point, a change of one in the right most digit is referred to as a count. For example, if there were no decimal point selected, a change from 235 to 236 is a change of one count. If the decimal point were selected at 0.0 , a change of 23.5 to 23.6 is a change of one count.

When setting up an alarm for deviation the deviation is set in counts. For example if a low alarm is required to be 5 counts below the $SP IH$, then set $ALLo$ to -5. If a high alarm is required 20 counts above the $SP IH$, then set $ALHi$ to +20. If $SP IH$ is changed, the alarm will continue to hold the same relationship as originally set.

When Alarm Power Interrupt, $ALPI$, is programmed ON and Alarm Reset, $ALrE$, is programmed for Hold, the alarm will automatically reset upon a power failure and subsequent restoration if no alarm condition is present.

If Alarm Inhibit, $ALIH$, is selected ON, an alarm condition is suspended upon power up until the process value passes through the alarm set point once. Alarm inhibit can be restored as if a power up took place by pressing both the **NEXT MENU & ENTER** keys for 5 seconds.



WARNING: IF INHIBIT IS ON AND A POWER FAILURE OCCURS DURING A HIGH ALARM, RESTORATION OF POWER WILL NOT CAUSE THE ALARM TO OCCUR IF THE PROCESS VALUE DOES NOT FIRST DROP BELOW THE HIGH ALARM SETTING. DO NOT USE THE ALARM INHIBIT FEATURE IF A HAZARD IS CREATED BY THIS ACTION. BE SURE TO TEST ALL COMBINATIONS OF HIGH AND LOW ALARM INHIBIT ACTIONS BEFORE PLACING CONTROL INTO OPERATION.

The following menu items apply only to the alarms.

- AL1** Alarm 1 function: Select **OFF**, **Lo**, **Hi**, or **HiLo**, Factory default is **Hi**.
- OFF** Alarm 1 is disabled. No Alarm 1 menu items appear in the Secondary or Secure menus.
- Lo** Low Alarm Only. **ALLo** appears in the Secondary Menu.

- H, High Alarm Only. A 1H appears in the Secondary Menu.
- H,Lo High and Low Alarms. Both A 1Lo ND A 1H, appear in the Secondary Menu, and share the same Alarm 1 Relay output.

If AL1 is set to OFF, go to A2L on the next page.

- A 1E Alarm 1 Type: Select A65 OR DE. Factory Default is A65.
 - A65. Absolute Alarm that may be set anywhere within the values of SCAL and SCAH and is independent of SP 1H.
 - DE Deviation Alarm that may be set as an offset from SP 1H. As SP 1H is changed the Alarm Point will track with SP 1H.

- A1RE Alarm 1 Reset: Select ONOF OR HOLD. Factory default is ONOF.
 - ONOF Automatic Reset.
 - HOLD Manual Reset. Reset (acknowledge) by simultaneously pressing the  NEXT MENU &  DOWN ARROW keys for 5 sec.

- A1P, Alarm 1 Power Interrupt: Select ON OR OFF. Factory default is OFF.
 - ON Alarm Power Interrupt is ON.
 - OFF Alarm Power Interrupt is OFF.

- A1,H Alarm 1 Inhibit: Select ON OR OFF. Factory default is OFF.
 - ON Alarm Inhibit is ON. Alarm action is suspended until the process value first enters a non-alarm condition.
 - OFF Alarm Inhibit is OFF



- A15T Alarm 1 Output State: Select CL05 OR OPEN. Factory default is CL05.
 - CL05 Closes Contacts at Alarm Set Point.
 - OPEN Opens Contacts at Alarm Set Point.

- A1LP Alarm 1 Lamp: Select 0 ON OR 0 OFF. Factory default is 0 ON.
 - 0 ON Alarm Lamp is ON when alarm contact is closed.
 - 0 OFF Alarm Lamp is OFF when alarm contact is closed.

- A1TD Alarm 1 time Delay: Select OFF OR 1 TO 8000 seconds. Factory default is OFF.
 - OFF Alarm function will operate when triggered at programmed Alarm Set Point.
 - 1-8000 Alarm function will only operate once the programmed time has elapsed after the alarm was triggered by the Alarm Set Point.

- AL2 Alarm 2 function: Select OFF, Lo, H, OR H,Lo Factory default is Lo.
- OFF Alarm 2 is disabled. No Alarm 2 menu items appear in the Secondary or Secure menus.
 - Lo Low Alarm Only. A2Lo appears in the Secondary Menu.
 - H, High Alarm Only. A2H, appears in the Secondary Menu.
 - H,Lo High and Low Alarms. Both A2Lo and A2H, appear in the Secondary Menu, and share the same Alarm 2 Relay output.

If AL2 is set to OFF the remaining A2, alarm 2, menu items do not appear.

- A2T Alarm 2 Type: Select A65 OR DE. Factory Default is A65.
- A65. Absolute Alarm that may be set anywhere within the values of SCAL and SCAH and is independent of SP1H.
 - DE Deviation Alarm that may be set as an offset from SP1H. As SP 1H is changed the Alarm Point will track with SP1H.
- A2RE Alarm 2 Reset: Select ONOF OR HOLD. Factory default is ONOF.
- ONOF Automatic Reset.
 - HOLD Manual Reset. Reset (acknowledge) by simultaneously pressing the  **NEXT MENU** &  **DOWN ARROW** keys for 5 sec.
- A2P, Alarm 2 Power Interrupt: Select ON OR OFF. Factory default is OFF.
- ON Alarm Power Interrupt is On.
 - OFF Alarm Power Interrupt is OFF.
- A2,H Alarm 2 Inhibit: Select ON OR OFF. Factory default is OFF.
- ON Alarm Inhibit is On. Alarm action is suspended until the process value first enters a non-alarm condition.
 - OFF Alarm Inhibit is OFF.
- A25T Alarm 2 Output State: Select CL05 OR OPEN. Factory default is CL05.
- CL05 Closes Contacts at Alarm Set Point.
 - OPEN Opens Contacts at Alarm Set Point.
- A2LP Alarm 2 Lamp: Select 0 ON OR 0 OFF. Factory default is 0 ON.
- 0 ON Alarm Lamp is ON when alarm contact is closed.
 - 0 OFF Alarm Lamp is OFF when alarm contact is closed.
- A2TD Alarm 2 time Delay: Select OFF OR 1 TO 8000 seconds. Factory default is OFF.
- OFF Alarm function will operate when triggered at programmed Alarm Set Point.
 - 1 - 8000 Alarm function will only operate once the programmed time has elapsed after the alarm was triggered by the Alarm Set Point.

FILt Digital Filter: Select *OFF* or *1* to *99*. In some cases the time constant of the sensor, or noise could cause the display to jump enough to be unreadable. If this value is set too high, controllability will suffer. Factory default is *3*.

POH (Analog Retransmission Output, see page 13) Process Output High: Select from any value greater than *POL* to 9999 counts. Factory default is *23.1*.

POL (Analog Retransmission Output, see page 13) Process Output Low: Select -1999 counts to any value less than *POH*. Factory default is *0.0*.

The remaining menu items appear if the corresponding option was purchased with the control.

LOrE (Option 232 and 485, Serial Communications) Local / Remote Status: Select *LOC* or *rE*. Factory default is *rE*.

LOC The host computer is advised not to send remote commands. Any write commands sent to the controls will be rejected.

rE The host computer is allowed to send write commands. If the control is not addressed within the time set in the *nARt* (No Activity Timer, see Secure Menu) the *CHEC LOrE* error message will be displayed.

Addr (Option 232 or 485, Serial Communications) Control Address: Set from *1 to FF* This number (hexadecimal, base 16) must match the address number used by the host computer. Factory default is *32*.

bAUD (Option 232 or 485, Serial Communications) Communication Baud Rate: Select *300, 1200, 2400, 4800, 9600, or 19200*. This number must match the baud rate used by the host computer. Factory default is *9600*.

nARt (Option 232 or 485, Serial Communications) No Activity Timer: Set from *OFF* or *1 to 99* minutes. Factory default is *OFF*.

1-99 Maximum time between host computer accesses. If timer counts to 0, *CHEC/LOrE* will be displayed.

OFF No Activity Timer function is disabled.

Stor (Option 232 or 485, Serial Communications) Store to EEPROM: Select *YES* or *no*.

YES Menu item changes made through serial communications are stored directly to EEPROM.

no Menu item changes made through serial communications are stored in RAM. (Settings are lost if power is disconnected)

DIAGNOSTIC ERROR MESSAGES

DISPLAY	MEANING	SP OUTPUTS	ACTION REQUIRED
No display lighted	Display is blank. Instrument is not getting power, or the supply voltage is too low.	Set point outputs inactive Alarms inactive	Check that the power supply is on, or that the external fuses are good.
<i>FAIL TEST</i>	Fail test appears upon power up if the internal diagnostics detect a failure. This message may occur during operation if a failure is detected. Displays flash.	Set point outputs inactive Alarms inactive	The display alternates between <i>FAIL TEST</i> and one of the following messages: <i>FACT dFLT</i> : Memory may be corrupted. Press the ENTER key and the DOWN ARROW key to start the factory default procedure. Recheck controller programming. <i>ret FACT</i> : Unrecoverable error, return to factory for service.
<i>CHCC LoRE</i>	This message appears if the Serial Communications has timed out.	Set point outputs active Alarms inactive	Restore the communications line and switch the <i>LoRE</i> to <i>LOC</i> .

DISPLAY	MEANING	SP OUTPUTS	ACTION REQUIRED
<p><i>UFL</i> or <i>OFL</i></p>	<p>Underflow or Overflow: Process value has exceeded input range ends.</p>	<p>Set point outputs active Alarms active</p>	<p>Input signals may normally go above or below range ends. If not, check input and correct.</p>
<p><i>CHEC CAL</i></p>	<p>Check calibration appears as an alternating message if the instrument calibration nears tolerance edges.</p> <p>Check calibration appears as a flashing message if the instrument calibration exceeds specification.</p>	<p>Set point outputs active Alarms active</p> <p>Set point outputs inactive Alarms active</p>	<p>Remove the instrument for service and / or recalibration. To reset use the NEXT MENU & ENTER keys.</p> <p>Remove the instrument for service and / or recalibration. To reset use the NEXT MENU & ENTER keys.</p>
<p><i>RrER</i> (Alternates with PV)</p> <p><i>RrER</i></p>	<p>This message appears if the ambient temperature of the control approaches the ends of tolerance.</p> <p>This message appears if the ambient temperature of the control is out of range or RJC sensor is broken.</p>	<p>Set point outputs active Alarm active</p> <p>Set point outputs active Alarms active</p>	<p>Correct the ambient temperature conditions. Ventilate the area of the cabinet or check for clogged filters. If RJC broken, return to factory for service.</p> <p>Correct the ambient temperature conditions. Ventilate the area of the cabinet or check for clogged filters. If RJC broken, return to factory for service.</p>

PROGRAMMING CHART

Use the charts on this and the next page to record the values in your application. You may want to photocopy the pages if you plan to make programming changes.

MENU	ITEM	DEFAULT	SET AT	DESCRIPTION
Primary	<i>PU SP 1H</i>			Home Position, Process Variable & SP1H's Value displayed

MENU	ITEM	DEFAULT	SET AT	DESCRIPTION
Secondary	<i>SP 1H</i>	<i>23.1</i>		Set Point 1 value (default is in feet)
	<i>SP 1L</i>	<i>0.0</i>		Set Point 1 off value (default is in feet)
	<i>SP 2H</i>	<i>23.1</i>		Set Point 2 value (default is in feet)
	<i>SP 2L</i>	<i>0.0</i>		Set Point 2 off value (default is in feet)
	<i>A 1H</i>	<i>23.1</i>		Alarm 1 (high) value (default is in feet)
	<i>A 2Lo</i>	<i>2.0</i>		Alarm 2 (low) value (default is in feet)
	<i>SF 51</i>	<i>120</i>		Pump 1 Seal Failure Set Point
	<i>SF 52</i>	<i>120</i>		Pump 2 Seal Failure Set Point
	<i>P 1rn</i>	XXXX		Total ON Time for Pump 1 in HOURS since last reset
	<i>P 2rn</i>	XXXX		Total ON Time for Pump 2 in HOURS since last reset
	<i>P 1SF</i>	----		Pump 1 Reset for Seal Failure (---- or FAIL)
	<i>P 2SF</i>	----		Pump 2 Reset for Seal Failure (---- or FAIL)
<i>P 1Ot</i>	----		Pump 1 Reset for Over Temperature (---- or FAIL)	
<i>P 2Ot</i>	---		Pump 2 Reset for Over Temperature (---- or FAIL)	

MENU	ITEM	DEFAULT	SET AT	DESCRIPTION
Secure	<i>SECr</i>	<i>4</i>		Security Selection
	<i>SCAH</i>	<i>23.1</i>		Scale High value (default is in feet)
	<i>SCAL</i>	<i>0.0</i>		Scale Low value (default is in feet)
	<i>dPt</i>	<i>0.0</i>		Decimal Point Positioning
	<i>S 1St</i>	<i>POut</i>		Set Point 1 State (selectable POut (Pumping Out) or PIn (Pumping In))
	<i>S 2St</i>	<i>POut</i>		Set Point 2 State (selectable POut (Pumping Out), PIn (Pumping In), or off)
	<i>LdLg</i>	<i>On</i>		Lead/Lag (selectable on or off)
	<i>InPC</i>	<i>0.0</i>		Input Correction
	<i>OSUP</i>	<i>On</i>		Zero Suppression (selectable on or off)
	<i>InP</i>	<i>Curr</i>		Input (selectable current or voltage)
	<i>POt</i>	<i>AUTO</i>		Pump Over Temperature controller action (selectable automatic or manual reset)

MENU	ITEM	DEFAULT	SET AT	DESCRIPTION
Secure	P5F	AUTO		Pump Seal Failure controller action (selectable automatic or manual reset)
	TEST	On		System Test (Selectable on or off)
	PrSt	On		Pump Run Time Rest (Selectable on or off)
	SPH	23.1		Set Point High value (default is in feet)
	SPL	0.0		Set Point Low value (default is in feet)
	S1P.	OFF		Set Point 1 Power Interrupt (selectable on or off)
	S1IH	OFF		Set Point 1 Inhibit (selectable on or off)
	S2P.	OFF		Set Point 2 Power Interrupt (selectable on or off)
	S2IH	OFF		Set Point 2 Inhibit (selectable on or off)
	PEA	XX		Peak, highest input value seen since last reset
	VAL	XX		Valley, lowest input value seen since last reset
	AL1	H.		Alarm 1 Function (selectable off, lo, hi, or hilo)
	A1t	ABS		Alarm Type 1 (selectable abs (absolute) or de (deviation))
	A1rE	OnOF		Alarm 1 Reset (selectable onof (auto) or hold (manual))
	A1P.	OFF		Alarm 1 Power Interrupt (selectable on or off)
	A1IH	OFF		Alarm 1 Inhibit (selectable on or off)
	A1St	CLOS		Alarm 1 Output State (selectable close or open)
	A1LP	On		Alarm 1 Lamp condition when contact is closed (selectable on or off)
	A1td	OFF		Alarm 1 Time Delay (selectable off or 1 to 8000 seconds)
	AL2	LO		Alarm 2 function (selectable off, lo, hi, or hilo)
	A2t	ABS		Alarm 2 Type (selectable abs (absolute) or de (deviation))
	A2rE	OnOF		Alarm 2 Reset (selectable onof (auto) or hold (manual))
	A2P.	OFF		Alarm 2 Power Interrupt (selectable on or off)
	A2IH	OFF		Alarm 2 Inhibit (selectable on or off)
	A2St	CLOS		Alarm 2 Output State (selectable close or open)
	A2LP	On		Alarm 2 Lamp condition when contact is closed (selectable on or off)
	A2td	OFF		Alarm 2 Time Delay (selectable Off or 1 to 8000 seconds)
Filt	3		Digital Filter	
POH	23.1		Process Output High (default is in feet)	

MENU	ITEM	DEFAULT	SET AT	DESCRIPTION
Secure	<i>POL</i>	<i>0.0</i>		Process Output Low (default is in feet)
	<i>LOrE</i>	<i>rE</i>		Local/Remote for computer communications
	<i>Addr</i>	<i>32</i>		Control Address for computer communications
	<i>bAUd</i>	<i>9600</i>		Baud Rate for computer communications
	<i>nAt</i>	<i>OFF</i>		No Activity Timer for computer communications
	<i>Stor</i>	<i>YES</i>		Store Menu for Hi speed writes (selectable yes or no)

PROGRAMMING EXAMPLE

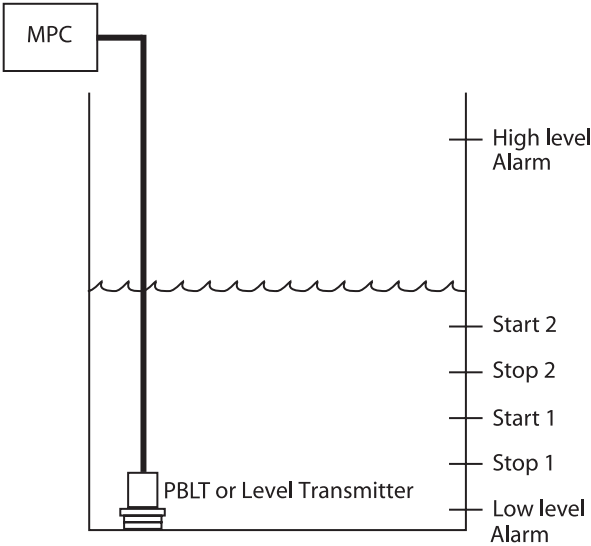

Example:

- Keep Empty, two pump (duplex)
- Depth 25 feet
- Pump 1: Start at 6 feet
Stop at 3 feet
- Pump 2: Start at 12 feet
Stop at 9 feet
- Low level alarm: 1 foot, fixed, auto reset
- High level alarm: 20 feet, fixed, auto reset
- Want Lead/Lag function on
- Automatic reset of pump over temperature and seal failure
- No communication options
- Want 4-20 mA retransmission
- Using with a 4-20 mA input.

EXAMPLE PROGRAMMING CHART

MENU	ITEM	DEFAULT	SET AT	DESCRIPTION
Secondary	SP1H	23.1	6.0	Set Point 1 value (default is in feet)
	SP1L	0.0	3.0	Set Point 1 off value (default is in feet)
	SP2H	23.1	12.0	Set Point 2 value (default is in feet)
	SP2L	0.0	9.0	Set Point 2 off value (default is in feet)
	A1H	23.1	20.0	Alarm 1 (high) value (default is in feet)
	A2Lo	2.0	1.0	Alarm 2 (low) value (default is in feet)
	SF51	120	120	Pump 1 Seal Failure Set Point
	SF52	120	120	Pump 2 Seal Failure Set Point
	P1rn	XXXX		Total ON Time for Pump 1 in HOURS since last reset
	P2rn	XXXX		Total ON Time for Pump 2 in HOURS since last reset
	P1SF	----		Pump 1 Reset for Seal Failure (---- or FAIL)
	P2SF	----		Pump 2 Reset for Seal Failure (---- or FAIL)
	P1Ot	----		Pump 1 Reset for Over Temperature (---- or FAIL)
P2Ot	----		Pump 2 Reset for Over Temperature (---- or FAIL)	

EXAMPLE PROGRAMMING CHART continued

MENU	ITEM	DEFAULT	SET AT	DESCRIPTION
Secure	<i>SECr</i>	<i>4</i>	<i>4</i>	Security Selection
	<i>SCAH</i>	<i>23.1</i>	<i>25.0</i>	Scale High value (default is in feet)
	<i>SCAL</i>	<i>0.0</i>	<i>0.0</i>	Scale Low value (default is in feet)
	<i>dPt</i>	<i>0.0</i>	<i>0.0</i>	Decimal Point Positioning
	<i>S1St</i>	<i>POut</i>	<i>POut</i>	Set Point 1 State (selectable POut (Pumping Out) or PIn (Pumping In))
	<i>S2St</i>	<i>POut</i>	<i>POut</i>	Set Point 2 State (selectable POut (Pumping Out), PIn (Pumping In), or off)
	<i>LdLg</i>	<i>On</i>	<i>On</i>	Lead/Lag (selectable on or off)
	<i>InPC</i>	<i>0.0</i>	<i>0.0</i>	Input Correction
	<i>OSUP</i>	<i>On</i>	<i>On</i>	Zero Suppression (selectable on or off)
	<i>InP</i>	<i>Curr</i>	<i>Curr</i>	Input (selectable current or voltage)
	<i>POt</i>	<i>AUTO</i>	<i>AUTO</i>	Pump Over Temperature controller action (selectable automatic or manual reset)
	<i>PSF</i>	<i>AUTO</i>	<i>AUTO</i>	Pump Seal Failure controller action (selectable automatic or manual reset)
	<i>tEST</i>	<i>On</i>	<i>On</i>	System Test (Selectable on or off)
	<i>PrSt</i>	<i>On</i>	<i>On</i>	Pump Run Time Rest (Selectable on or off)
	<i>SPH</i>	<i>23.1</i>	<i>25.0</i>	Set Point High value (default is in feet)
	<i>SPL</i>	<i>0.0</i>	<i>0.0</i>	Set Point Low value (default is in feet)
	<i>S1P.</i>	<i>OFF</i>	<i>OFF</i>	Set Point 1 Power Interrupt (selectable on or off)
	<i>S1.H</i>	<i>OFF</i>	<i>OFF</i>	Set Point 1 Inhibit (selectable on or off)
	<i>S2P.</i>	<i>OFF</i>	<i>OFF</i>	Set Point 2 Power Interrupt (selectable on or off)
	<i>S2.H</i>	<i>OFF</i>	<i>OFF</i>	Set Point 2 Inhibit (selectable on or off)
<i>PEA</i>	XX		Peak, highest input value seen since last reset	
<i>VAL</i>	XX		Valley, lowest input value seen since last reset	

EXAMPLE PROGRAMMING CHART continued

MENU	ITEM	DEFAULT	SET AT	DESCRIPTION
Secure	<i>AL1</i>	<i>H1</i>	<i>H1</i>	Alarm 1 Function (selectable off, lo, hi, or hilo)
	<i>A1t</i>	<i>ABS</i>	<i>ABS</i>	Alarm Type 1 (selectable abs (absolute) or de (deviation))
	<i>A1rE</i>	<i>OnOF</i>	<i>OnOF</i>	Alarm 1 Reset (selectable onof (auto) or hold (manual))
	<i>A1P1</i>	<i>OFF</i>	<i>OFF</i>	Alarm 1 Power Interrupt (selectable on or off)
	<i>A1IH</i>	<i>OFF</i>	<i>OFF</i>	Alarm 1 Inhibit (selectable on or off)
	<i>A1St</i>	<i>CLOS</i>	<i>CLOS</i>	Alarm 1 Output State (selectable close or open)
	<i>A1LP</i>	<i>On</i>	<i>On</i>	Alarm 1 Lamp condition when contact is closed (selectable on or off)
	<i>A1td</i>	<i>OFF</i>	<i>OFF</i>	Alarm 1 Time Delay (selectable off or 1 to 8000 seconds)
	<i>AL2</i>	<i>Lo</i>	<i>Lo</i>	Alarm 2 function (selectable off, lo, hi, or hilo)
	<i>A2t</i>	<i>ABS</i>	<i>ABS</i>	Alarm 2 Type (selectable abs (absolute) or de (deviation))
	<i>A2rE</i>	<i>OnOF</i>	<i>OnOF</i>	Alarm 2 Reset (selectable onof (auto) or hold (manual))
	<i>A2P1</i>	<i>OFF</i>	<i>OFF</i>	Alarm 2 Power Interrupt (selectable on or off)
	<i>A2IH</i>	<i>OFF</i>	<i>OFF</i>	Alarm 2 Inhibit (selectable on or off)
	<i>A2St</i>	<i>CLOS</i>	<i>CLOS</i>	Alarm 2 Output State (selectable close or open)
	<i>A2LP</i>	<i>On</i>	<i>On</i>	Alarm 2 Lamp condition when contact is closed (selectable on or off)
	<i>A2td</i>	<i>OFF</i>	<i>OFF</i>	Alarm 2 Time Delay (selectable Off or 1 to 8000 seconds)
	<i>Filt</i>	<i>3</i>	<i>3</i>	Digital Filter
	<i>POH</i>	<i>231</i>	<i>250</i>	Process Output High (default is in feet)
<i>POL</i>	<i>00</i>	<i>00</i>	Process Output Low (default is in feet)	



BLUE RIBBON SALES & SERVICES

2770 Long Road, Grand Island, NY 14072

Tel. (716) 773-9300 • Fax (716) 773-5019

brsales@blueribboncorp.com • www.blueribboncorp.com